



## PSA Serisi Pako Şalterler

- Yüksek doğruluk
- Geniş uygulama alanları için ürün çeşitliliği
- Uzun ömür
- Yüksek kontak güvenilirliği
- Kompakt tasarım ve sağlamlık
- Parmak ergonomisine uygun tasarım ve kolay fark edilebilen kademeler

### Teknik Bilgiler

Mekanik Ömür	: 100.000 açma-kapama min.
Elektriksel Ömür	: 50.000 açma-kapama min.
Çalışma Sıcaklığı	: -5 / +40°C
Koruma Derecesi	: IP20 (Kontakt Blok), IP54 ve IP65 kutu içinde
Kısa Devre Kesme Kapasitesi	: 6kA
Anma İşletme Gerilimi Ue	: 400 V AC
Anma İşletme Akımı Ie	: 10-100 A
İzolasyon Direnci	: 10 MΩ min. (500 V DC)
Kontakt Direnci	: maks. 15 mΩ
Dielektrik Mukavemeti	: (1 dakika için) 2000 V AC
Standart	: TS EN 60947-3



## PSA Series Cam Switches

- High precision
- Variety of products for wide application fields
- Long life time
- High contact reliability
- Compact design and reliability
- Handle designed in conformity with finger ergonomiy and easily perceivable grades

### Technical Information

Mechanical Life	: 100.000 operations min.
Electrical Life	: 50.000 operations min.
Operating Temperature	: -5 / +40°C
Protection Degree	: IP20 (Contacts), IP54 and IP65 (Front Protection)
Short Circuit Breaking Capacity	: 6 kA
Rated Operating Voltage Ue	: 400 V AC
Rated Operating Current Ie	: 10 -100 A
Insulation Resistance	: 10 MΩ min. (500 V DC)
Contact Resistance	: max. 15 mΩ
Dielectrical Strength	: (for 1 minute) 1500 V AC
Standard	: TS EN 60947-3



# Pako Şalterler ve Pako Kutuları

## Cam Switches and Enclosures

### Pako Şalterlerin Seçim Tablosu

#### Cam Switches Selection Table

Grup	Seri	Amper	Tip	Kutup	Açı	Etiket	Opsiyon
<b>PS</b>	<b>A</b>	<b>010</b>	<b>AK</b>	<b>1</b>	<b>3</b>	<b>1</b>	<b>S</b>
Group	Series	Amper	Type	Pole	Angle	Label	Option
<b>PS</b> PS Grubu PS Group	<b>A</b> A Serisi A Series	<b>Amper</b> Amper	<b>Tip</b> Type	<b>Kutup</b> Pole	<b>Açı</b> Angle	<b>Etiket</b> Label	<b>Opsiyon</b> Option
		<b>10</b>	<b>AK</b> Aç Kapa On-Off	<b>1</b>	<b>1</b> 30° Açı 30° Angle	<b>1</b>	<b>S</b> 48X48 Normal 48X48 Normal
		<b>16</b>	<b>KD</b> Kutup Değiştirici Change Over	<b>2</b>	<b>2</b> 45° Açı 45° Angle	<b>2</b>	<b>E</b> 48X48 Emniyet Sarı Kırmızı 48X48 Emergency Yellow Red
		<b>20</b>	<b>KS</b> Kademeli Şalter Step	<b>3</b>	<b>3</b> 60° Açı 60° Angle	<b>3</b>	<b>B</b> 64x64 Normal 64x64 Normal
		<b>25</b>	<b>KT</b> Kademeli Toplamalı Multi Step	<b>4</b>	<b>4</b> 90° Açı 90° Angle	<b>4</b>	<b>F</b> 64x64 Emniyet 64x64 Emergency
		<b>32</b>	<b>MS</b> Motor Şalteri Motor Control		<b>5</b> 90° Açı (Yaylı Geri Dönüşlü) 90° Angle (Push Button)	<b>5</b>	<b>AQ</b> Anahtarlı Hızlı Montaj Key Operated Fast Montage
		<b>40</b>	<b>MS</b> Çift Devir Double Speed Motor Switch			<b>6</b>	<b>K</b> Tutamaktan Kilit Takılabilen Padlockable Handle
		<b>50</b>	<b>OK</b> Ölçü Komutatorü Measure Commutator			<b>7</b>	
		<b>63</b>	<b>Z</b> Özel Pako Special Cam Switch				
		<b>80</b>					
		<b>115</b>					

#### Etiket / Label

1. Tip 1. Type	2. Tip* 2. Type*	3. Tip** 3. Type**	4. Tip*** 4. Type***
<b>1</b> 0 - 1	<b>2</b> 0 - 1 - 2	<b>5</b>	<b>1</b> Faz - Nötr Phase - Neutral
<b>2</b> 0 - 1 - 2	<b>3</b> 0 - 3	** Motor kumandası için ** For motor control	<b>2</b> Faz - Faz Phase - Phase
<b>3</b> 1 - 2	<b>4</b> 0 - 4		<b>3</b> Faz - Nötr ve Faz - Faz Phase - Neutral and Phase - Phase
<b>4</b> 1 - 0 - 2	<b>5</b> 0 - 5		<b>6</b> Ampermetre Ampermeter
	<b>6</b> 0 - 6		*** Ölçü komütatörleri için *** For measure commutator switches
	<b>7</b> 0 - 7		

\* Kademeli Şalterler için  
\* For Multi Step Switches

**Örnek:** PSA032AK131B → PSA Serisi, 32A, 1 kutuplu, 60° dönüşlü, 0-1 açma-kapama Pako şalteri seçilmiştir.

**Example:** PSA032AK131B → PSA Series, 32 A, 1 pole, 60 degrees rotational, 0-1 on-off Cam switch has been selected.

## Pako Grupları

Pako Groups



**48x48 Normal**



**64x64 Normal**



**PSK11**



**PSK12**

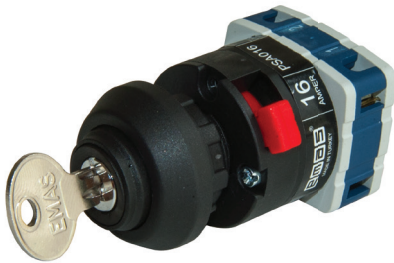

**AQ Anahtarlı Hızlı Montaj**  
AQ Key Operated Fast montage

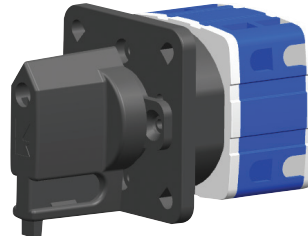

**K Tutamaktan Kilit Takılabilen**  
K Padlockable Handle

# Pako Şalterler ve Pako Kutuları

## Cam Switches and Enclosures

### "0-1" Aç-Kapa Pako Şalterler - 60° / 0-1 On-Off Cam Switches - 60°

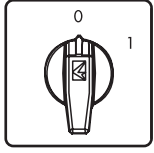

PSA020AK131S

Ürün Kodu Code	Faz Sayısı Poles	Anma Termik Akımı (A) Rated Thermal Current (A)	Uygun Kutu Kodu Enclosure	Anahtarlı Kafa Uyarlanabilir Key Operated	Kontak Şeması Schema
PSA010AK131S	1 Faz / 1 Pole	10	PSK11	✓	
PSA016AK131S	1 Faz / 1 Pole	16	PSK11	✓	
PSA020AK131S	1 Faz / 1 Pole	20	PSK11	✓	
PSA025AK131S	1 Faz / 1 Pole	25	PSK11	✓	
PSA032AK131S	1 Faz / 1 Pole	32	PSK21		
PSA040AK131S	1 Faz / 1 Pole	40	PSK21		
PSA050AK131S	1 Faz / 1 Pole	50	-		
PSA063AK131S	1 Faz / 1 Pole	63	-		
PSA080AK131S	1 Faz / 1 Pole	80	-		
PSA115AK131S	1 Faz / 1 Pole	115	-		



PSA020AK231S

PSA010AK231S	2 Faz / 2 Poles	10	PSK11	✓	
PSA016AK231S	2 Faz / 2 Pole	16	PSK11	✓	
PSA020AK231S	2 Faz / 2 Poles	20	PSK11	✓	
PSA025AK231S	2 Faz / 2 Poles	25	PSK11	✓	
PSA032AK231S	2 Faz / 2 Poles	32	PSK21		
PSA040AK231S	2 Faz / 2 Poles	40	PSK21		
PSA050AK231S	2 Faz / 2 Poles	50	-		
PSA063AK231S	2 Faz / 2 Poles	63	-		
PSA080AK231S	2 Faz / 2 Poles	80	-		
PSA115AK231S	2 Faz / 2 Poles	115	-		



PSA020AK331S

PSA010AK331S	3 Faz / 3 Poles	10	PSK11	✓	
PSA016AK331S	3 Faz / 3 Poles	16	PSK11	✓	
PSA020AK331S	3 Faz / 3 Poles	20	PSK11	✓	
PSA025AK331S	3 Faz / 3 Poles	25	PSK11	✓	
PSA032AK331S	3 Faz / 3 Poles	32	PSK21		
PSA040AK331S	3 Faz / 3 Poles	40	PSK21		
PSA050AK331S	3 Faz / 3 Poles	50	-		
PSA063AK331S	3 Faz / 3 Poles	63	-		
PSA080AK331S	3 Faz / 3 Poles	80	-		
PSA115AK331S	3 Faz / 3 Poles	115	-		



PSA020AK431S

PSA010AK431S	4 Faz / 4 Poles	10	PSK11	✓	
PSA016AK431S	4 Faz / 4 Poles	16	PSK11	✓	
PSA020AK431S	4 Faz / 4 Poles	20	PSK11	✓	
PSA025AK431S	4 Faz / 4 Poles	25	PSK11	✓	
PSA032AK431S	4 Faz / 4 Poles	32	PSK21		
PSA040AK431S	4 Faz / 4 Poles	40	PSK21		
PSA050AK431S	4 Faz / 4 Poles	50	-		
PSA063AK431S	4 Faz / 4 Poles	63	-		
PSA080AK431S	4 Faz / 4 Poles	80	-		
PSA115AK431S	4 Faz / 4 Poles	115	-		



PSA020AK831S

PSA010AK831S	3 Faz+Nötr / 3 Poles+Neutral	10	PSK11	✓	
PSA016AK831S	3 Faz+Nötr / 3 Poles+Neutral	16	PSK11	✓	
PSA020AK831S	3 Faz+Nötr / 3 Poles+Neutral	20	PSK11	✓	
PSA025AK831S	3 Faz+Nötr / 3 Poles+Neutral	25	PSK11	✓	
PSA032AK831S	3 Faz+Nötr / 3 Poles+Neutral	32	PSK21		
PSA040AK831S	3 Faz+Nötr / 3 Poles+Neutral	40	PSK21		
PSA050AK831S	3 Faz+Nötr / 3 Poles+Neutral	50	-		
PSA063AK831S	3 Faz+Nötr / 3 Poles+Neutral	63	-		
PSA080AK831S	3 Faz+Nötr / 3 Poles+Neutral	80	-		
PSA115AK831S	3 Faz+Nötr / 3 Poles+Neutral	115	-		

- İstendiği takdirde, 10-25A bir büyük boy çerçeve ile montaj yapılabilir (64x64), bu durumda sondaki "S" yerine "B" konması gerekmektedir.
- Anahtarlı sütunda işaretli olan modeller çabuk montajlı Anahtarlı Kafa için uygundur.

\* 10-25A Cam switches could be supplied with big frame (64x64) with extra charge. In this case please replace the "S" at the end with "B".

\* Products are in the Key Operated columns are available for fast mounting Key Head with extra charge. In this case, replace S letter at the end of the code with AQ

## Emniyet Tipi Aç-Kapa Pako Şalterler - 90° / 0-1 Safety On-Off Cam Switches - 90°

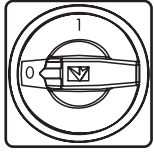

PSA020AK141E

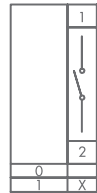
Ürün Kodu Code	Faz Sayısı Poles	Anma Termik Akımı (A) Rated Thermal Current (A)	Uygun Kutu Kodu Enclosure	Anahtarlı Kafa Uyarlanabilir Key Operated	Kontak Şeması Schema
PSA010AK141E	1 Faz / 1 Pole	10	PSK11		
PSA016AK141E	1 Faz / 1 Pole	16	PSK11		
PSA020AK141E	1 Faz / 1 Pole	20	PSK11		
PSA025AK141E	1 Faz / 1 Pole	25	PSK11		
PSA032AK141E	1 Faz / 1 Pole	32	PSK21		
PSA040AK141E	1 Faz / 1 Pole	40	PSK21		
PSA050AK141E	1 Faz / 1 Pole	50	-		
PSA063AK141E	1 Faz / 1 Pole	63	-		
PSA080AK141E	1 Faz / 1 Pole	80	-		
PSA115AK141E	1 Faz / 1 Pole	115	-		

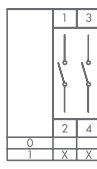

PSA020AK241E

PSA010AK241E	2 Faz / 2 Poles	10	PSK11		
PSA016AK241E	2 Faz / 2 Pole	16	PSK11		
PSA020AK241E	2 Faz / 2 Poles	20	PSK11		
PSA025AK241E	2 Faz / 2 Poles	25	PSK11		
PSA032AK241E	2 Faz / 2 Poles	32	PSK21		
PSA040AK241E	2 Faz / 2 Poles	40	PSK21		
PSA050AK241E	2 Faz / 2 Poles	50	-		
PSA063AK241E	2 Faz / 2 Poles	63	-		
PSA080AK241E	2 Faz / 2 Poles	80	-		
PSA115AK241E	2 Faz / 2 Poles	115	-		

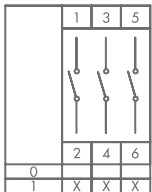

PSA020AK341E

PSA010AK341E	3 Faz / 3 Poles	10	PSK11		
PSA016AK341E	3 Faz / 3 Poles	16	PSK11		
PSA020AK341E	3 Faz / 3 Poles	20	PSK11		
PSA025AK341E	3 Faz / 3 Poles	25	PSK11		
PSA032AK341E	3 Faz / 3 Poles	32	PSK21		
PSA040AK341E	3 Faz / 3 Poles	40	PSK21		
PSA050AK341E	3 Faz / 3 Poles	50	-		
PSA063AK341E	3 Faz / 3 Poles	63	-		
PSA080AK341E	3 Faz / 3 Poles	80	-		
PSA115AK341E	3 Faz / 3 Poles	115	-		

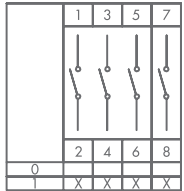

PSA020AK441E

PSA010AK441E	4 Faz / 4 Poles	10	PSK11		
PSA016AK441E	4 Faz / 4 Poles	16	PSK11		
PSA020AK441E	4 Faz / 4 Poles	20	PSK11		
PSA025AK441E	4 Faz / 4 Poles	25	PSK11		
PSA032AK441E	4 Faz / 4 Poles	32	PSK21		
PSA040AK441E	4 Faz / 4 Poles	40	PSK21		
PSA050AK441E	4 Faz / 4 Poles	50	-		
PSA063AK441E	4 Faz / 4 Poles	63	-		
PSA080AK441E	4 Faz / 4 Poles	80	-		
PSA115AK441E	4 Faz / 4 Poles	115	-		

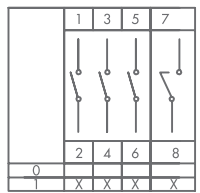

PSA020AK941E

PSA010AK941E	3 Faz+Nötr / 3 Poles+Neutral	10	PSK11		
PSA016AK941E	3 Faz+Nötr / 3 Poles+Neutral	16	PSK11		
PSA020AK941E	3 Faz+Nötr / 3 Poles+Neutral	20	PSK11		
PSA025AK941E	3 Faz+Nötr / 3 Poles+Neutral	25	PSK11		
PSA032AK941E	3 Faz+Nötr / 3 Poles+Neutral	32	PSK21		
PSA040AK941E	3 Faz+Nötr / 3 Poles+Neutral	40	PSK21		
PSA050AK941E	3 Faz+Nötr / 3 Poles+Neutral	50	-		
PSA063AK941E	3 Faz+Nötr / 3 Poles+Neutral	63	-		
PSA080AK941E	3 Faz+Nötr / 3 Poles+Neutral	80	-		
PSA115AK941E	3 Faz+Nötr / 3 Poles+Neutral	115	-		

• İstendiği takdirde, 10-25A bir büyük boy çerçeve ile montaj yapılabilir (64x64), bu durumda sondaki "S" yerine "B" konması gerekmektedir.

- Anahtarlı sütunda işaretli olan modeller çabuk montajlı Anahtarlı Kafa için uygundur.
- Tutamaktan Kilit Takılabilen Kafa Modeli Emniyet Tipi Pakolar için uygundur.

\* 10-25A Cam switches could be supplied with big frame (64x64) with extra charge. In this case please replace the "S" at the end with "B".

\* Products are in the Key Operated columns are available for fast mounting Key Head with extra charge. In this case, replace S letter at the end of the code with AQ

\* Padlockable Handle Head models are available for Emergency type Cam switches

# Pako Şalterler ve Pako Kutuları

## Cam Switches and Enclosures

### “1-2” Kutup Değişiriciler - 60° / 1-2 Changeover Cam Switches- 60°

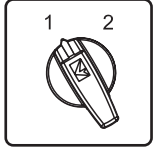

PSA020KD133S

Ürün Kodu Code	Kutup Sayısı Poles	Anma Termik Akımı (A) Rated Thermal Current (A)	Uygun Kutu Kodu Enclosure	Anahtarlı Kafa Uyarlanabilir Key Operated	Kontak Şeması Schema
PSA010KD133S	1 Kutup / 1 Pole	10	PSK11		
PSA016KD133S	1 Kutup / 1 Pole	16	PSK11		
PSA020KD133S	1 Kutup / 1 Pole	20	PSK11		
PSA025KD133S	1 Kutup / 1 Pole	25	PSK11		
PSA032KD133S	1 Kutup / 1 Pole	32	PSK21		
PSA040KD133S	1 Kutup / 1 Pole	40	PSK21		
PSA050KD133S	1 Kutup / 1 Pole	50	-		
PSA063KD133S	1 Kutup / 1 Pole	63	-		
PSA080KD133S	1 Kutup / 1 Pole	80	-		
PSA115KD133S	1 Kutup / 1 Pole	115	-		



PSA010KD233S

PSA010KD233S	2 Kutup / 2 Poles	10	PSK11		
PSA016KD233S	2 Kutup / 2 Poles	16	PSK11		
PSA020KD233S	2 Kutup / 2 Poles	20	PSK11		
PSA025KD233S	2 Kutup / 2 Poles	25	PSK11		
PSA032KD233S	2 Kutup / 2 Poles	32	-		
PSA040KD233S	2 Kutup / 2 Poles	40	-		
PSA050KD233S	2 Kutup / 2 Poles	50	-		
PSA063KD233S	2 Kutup / 2 Poles	63	-		



PSA020KD333S

PSA010KD333S	3 Kutup / 3 Poles	10	PSK12		
PSA016KD333S	3 Kutup / 3 Poles	16	PSK12		
PSA020KD333S	3 Kutup / 3 Poles	20	PSK12		
PSA025KD333S	3 Kutup / 3 Poles	25	PSK12		
PSA032KD333S	3 Kutup / 3 Poles	32	-		
PSA040KD333S	3 Kutup / 3 Poles	40	-		
PSA050KD333S	3 Kutup / 3 Poles	50	-		
PSA063KD333S	3 Kutup / 3 Poles	63	-		

- İstendiği takdirde, 10-25A bir büyük boy çerçeve ile montaj yapılabilir (64x64), bu durumda sondaki "S" yerine "B" konması gerekmektedir.
- Anahtarlı sütunda işaretli olan modeller çabuk montajlı Anahtarlı Kafa için uygundur.

\* 10-25A Cam switches could be supplied with big frame (64x64) with extra charge. In this case please replace the "S" at the end with "B".

\* Products are in the Key Operated columns are available for fast mounting Key Head with extra charge. In this case, replace S letter at the end of the code with AQ

## “1-0-2” Kutup Değişiriciler - 60° / 1-0-2 Changeover Cam Switches- 60°

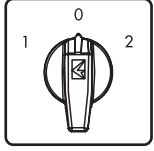

PSA020KD134S

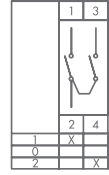
Ürün Kodu Code	Kutup Sayısı Poles	Anma Termik Akımı (A) Rated Thermal Current (A)	Uygun Kutu Kodu Enclosure	Anahtarlı Kafa Uyarlanabilir Key Operated	Kontakt Şeması Schema
PSA010KD134S	1 Kutup / 1 Pole	10	PSK11	✓	
PSA016KD134S	1 Kutup / 1 Pole	16	PSK11	✓	
PSA020KD134S	1 Kutup / 1 Pole	20	PSK11	✓	
PSA025KD134S	1 Kutup / 1 Pole	25	PSK11	✓	
PSA032KD134S	1 Kutup / 1 Pole	32	PSK21		
PSA040KD134S	1 Kutup / 1 Pole	40	PSK21		
PSA050KD134S	1 Kutup / 1 Pole	50	-		
PSA063KD134S	1 Kutup / 1 Pole	63	-		
PSA080KD134S	1 Kutup / 1 Pole	80	-		
PSA115KD134S	1 Kutup / 1 Pole	115	-		

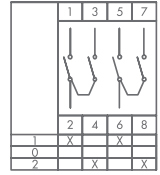

PSA020KD234S

PSA010KD234S	2 Kutup / 2 Poles	10	PSK11	✓	
PSA016KD234S	2 Kutup / 2 Poles	16	PSK11	✓	
PSA020KD234S	2 Kutup / 2 Poles	20	PSK11	✓	
PSA025KD234S	2 Kutup / 2 Poles	25	PSK11	✓	
PSA032KD234S	2 Kutup / 2 Poles	32	PSK21		
PSA040KD234S	2 Kutup / 2 Poles	40	PSK21		
PSA050KD234S	2 Kutup / 2 Poles	50	-		
PSA063KD234S	2 Kutup / 2 Poles	63	-		
PSA080KD234S	2 Kutup / 2 Poles	80	-		
PSA115KD234S	2 Kutup / 2 Poles	115	-		

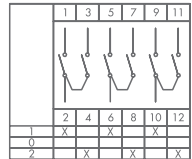

PSA020KD334S

PSA010KD334S	3 Kutup / 3 Poles	10	PSK12	✓	
PSA016KD334S	3 Kutup / 3 Poles	16	PSK12	✓	
PSA020KD334S	3 Kutup / 3 Poles	20	PSK12	✓	
PSA025KD334S	3 Kutup / 3 Poles	25	PSK12	✓	
PSA032KD334S	3 Kutup / 3 Poles	32	PSK22		
PSA040KD334S	3 Kutup / 3 Poles	40	PSK22		
PSA050KD334S	3 Kutup / 3 Poles	50	-		
PSA063KD334S	3 Kutup / 3 Poles	63	-		
PSA080KD334S	3 Kutup / 3 Poles	80	-		
PSA115KD334S	3 Kutup / 3 Poles	115	-		

- İstendiği takdirde, 10-25A bir büyük boy çerçeve ile montaj yapılabilir (64x64), bu durumda sondaki “S” yerine “B” konması gerekmektedir.
- Anahtarlı sütunda işaretli olan modeller çabuk montajlı Anahtarlı Kafa için uygundur.

\* 10-25A Cam switches could be supplied with big frame (64x64) with extra charge. In this case please replace the “S” at the end with “B”.

\* Products are in the Key Operated columns are available for fast mounting Key Head with extra charge. In this case, replace S letter at the end of the code with AQ

# Pako Şalterler ve Pako Kutuları

## Cam Switches and Enclosures

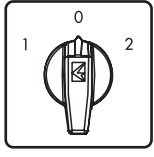

PSA020KD434S

Ürün Kodu Code	Kutup Sayısı Poles	Anma Termik Akımı (A) Rated Thermal Current (A)	Uygun Kutu Kodu Enclosure	Anahtarlı Kafa Uyarlanabilir Key Operated
PSA010KD434S	4 Kutup / 4 Poles	10	PSK12	✓
PSA016KD434S	4 Kutup / 4 Poles	16	PSK12	✓
PSA020KD434S	4 Kutup / 4 Poles	20	PSK12	✓
PSA025KD434S	4 Kutup / 4 Poles	25	PSK12	✓
PSA032KD434S	4 Kutup / 4 Poles	32	PSK22	
PSA040KD434S	4 Kutup / 4 Poles	40	PSK22	
PSA050KD434S	4 Kutup / 4 Poles	50	-	
PSA063KD434S	4 Kutup / 4 Poles	63	-	
PSA080KD434S	4 Kutup / 4 Poles	80	-	
PSA115KD434S	4 Kutup / 4 Poles	115	-	

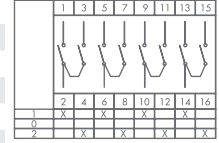

### Kademeli Şalterler - 1 Faz / Step Cam Switches - 1 Pole

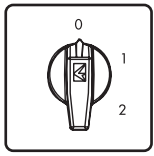

PSA020KS132S

Ürün Kodu Code	Kademe Steps	Anma Termik Akımı (A) Rated Thermal Current (A)	Uygun Kutu Kodu Enclosure	Anahtarlı Kafa Uyarlanabilir Key Operated
PSA010KS132S	0-1-2	10	PSK11	✓
PSA016KS132S	0-1-2	16	PSK11	✓
PSA020KS132S	0-1-2	20	PSK11	✓
PSA025KS132S	0-1-2	25	PSK11	✓
PSA032KS132S	0-1-2	32	PSK21	
PSA040KS132S	0-1-2	40	PSK21	
PSA050KS132S	0-1-2	50	-	
PSA063KS132S	0-1-2	63	-	
PSA080KS132S	0-1-2	80	-	
PSA115KS132S	0-1-2	115	-	

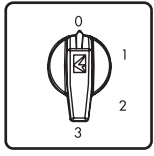
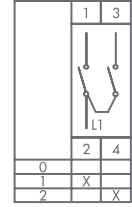

PSA020KS133S

PSA010KS133S	0-3	10	PSK11	✓
PSA016KS133S	0-3	16	PSK11	✓
PSA020KS133S	0-3	20	PSK11	✓
PSA025KS133S	0-3	25	PSK11	✓
PSA032KS133S	0-3	32	PSK21	
PSA040KS133S	0-3	40	PSK21	
PSA050KS133S	0-3	50	-	
PSA063KS133S	0-3	63	-	
PSA080KS133S	0-3	80	-	
PSA115KS133S	0-3	115	-	

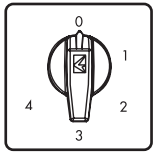
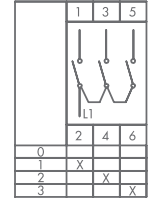

PSA020KS134S

PSA010KS134S	0-4	10	PSK12	✓
PSA016KS134S	0-4	16	PSK12	✓
PSA020KS134S	0-4	20	PSK12	✓
PSA025KS134S	0-4	25	PSK12	✓
PSA032KS134S	0-4	32	PSK22	
PSA040KS134S	0-4	40	PSK22	
PSA050KS134S	0-4	50	-	
PSA063KS134S	0-4	63	-	
PSA080KS134S	0-4	80	-	
PSA115KS134S	0-4	115	-	

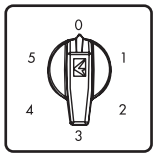
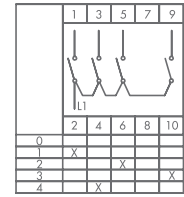

PSA020KS135S

PSA010KS135S	0-5	10	PSK12	✓
PSA016KS135S	0-5	16	PSK12	✓
PSA020KS135S	0-5	20	PSK12	✓
PSA025KS135S	0-5	25	PSK12	✓
PSA032KS135S	0-5	32	PSK22	
PSA040KS135S	0-5	40	PSK22	
PSA050KS135S	0-5	50	-	
PSA063KS135S	0-5	63	-	
PSA080KS135S	0-5	80	-	
PSA115KS135S	0-5	115	-	

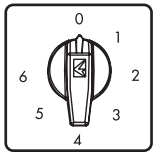
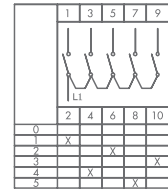

PSA020KS126S

PSA010KS126S	0-6	10	PSK12	
PSA016KS126S	0-6	16	PSK12	
PSA020KS126S	0-6	20	PSK12	
PSA025KS126S	0-6	25	PSK12	✓
PSA032KS126S	0-6	32	PSK22	
PSA040KS126S	0-6	40	PSK22	
PSA050KS126S	0-6	50	-	
PSA063KS126S	0-6	63	-	
PSA080KS126S	0-6	80	-	
PSA115KS126S	0-6	115	-	

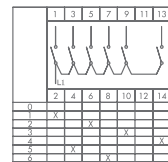



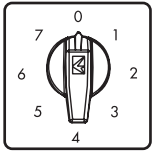

PSA020KS127S

Ürün Kodu Code	Kademe Steps	Anma Termik Akımı (A) Rated Thermal Current (A)	Uygun Kutu Kodu Enclosure	Anahtarlı Kafa Uyarlanabilir Key Operated	Kontakt Şeması Schema
PSA010KS127S	0-7	10	PSK12		
PSA016KS127S	0-7	16	PSK12		
PSA020KS127S	0-7	20	PSK12		
PSA025KS127S	0-7	25	PSK12		
PSA032KS127S	0-7	32	PSK22		
PSA040KS127S	0-7	40	PSK22		
PSA050KS127S	0-7	50	-		
PSA063KS127S	0-7	63	-		
PSA080KS127S	0-7	80	-		
PSA115KS127S	0-7	115	-		

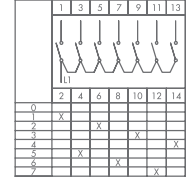

### Kademeli Toplamalı Şalterler - 60° / Step Cam Switches- 60°

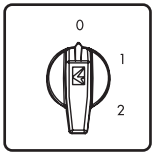

PSA020KT132S

Ürün Kodu Code	Kutup Sayısı Poles	Anma Termik Akımı (A) Rated Thermal Current (A)	Kademe Steps	Uygun Kutu Kodu Enclosure	Anahtarlı Kafa Uyarlanabilir Key Operated	Kontakt Şeması Schema
PSA010KT132S	1 Kutup / 1 Pole	10	0-1-2	PSK11	✓	
PSA016KT132S	1 Kutup / 1 Pole	16	0-1-2	PSK11	✓	
PSA020KT132S	1 Kutup / 1 Pole	20	0-1-2	PSK11	✓	
PSA025KT132S	1 Kutup / 1 Pole	25	0-1-2	PSK11	✓	
PSA010KT332S	3 Kutup / 3 Poles	10	0-1-2	PSK12	✓	
PSA016KT332S	3 Kutup / 3 Poles	16	0-1-2	PSK12	✓	

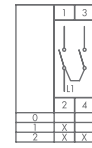

### MOTOR KORUMA ŞALTERLERİ / MOTOR CONTROL CAM SWITCHES

#### Yıldız Üçgen Kumanda Şalterleri - 60° / Star - Delta Cam Switches-60°

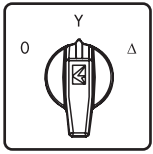

PSA020MS335S

Ürün Kodu Code	Faz Sayısı Poles	Anma Termik Akımı (A) Rated Thermal Current (A)	Uygun Kutu Kodu Enclosure	Anahtarlı Kafa Uyarlanabilir Key Operated	Kontakt Şeması Schema
PSA010MS335S	3 Faz / 3 Poles	10	PSK12	✓	
PSA016MS335S	3 Faz / 3 Poles	16	PSK12	✓	
PSA020MS335S	3 Faz / 3 Poles	20	PSK12	✓	
PSA025MS335S	3 Faz / 3 Poles	25	PSK12	✓	
PSA032MS335S	3 Faz / 3 Poles	32	PSK22		
PSA040MS335S	3 Faz / 3 Poles	40	PSK22		
PSA050MS335S	3 Faz / 3 Poles	50	-		
PSA063MS335S	3 Faz / 3 Poles	63	-		
PSA080MS335S	3 Faz / 3 Poles	80	-		
PSA115MS335S	3 Faz / 3 Poles	115	-		

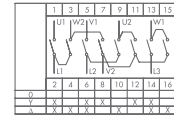

#### 1 Faz Enversör Şalterler 'I-0-II' / 1 Pole Inversor Cam Switches 'I-0-II'

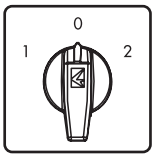

PSA020MS134S

Ürün Kodu Code	Faz Sayısı Poles	Anma Termik Akımı (A) Rated Thermal Current (A)	Kademe Steps	Uygun Kutu Kodu Enclosure	Anahtarlı Kafa Uyarlanabilir Key Operated	Kontakt Şeması Schema
PSA010MS134S	1 Faz / 1 Pole	10	1-0-2	PSK11	✓	
PSA016MS134S	1 Faz / 1 Pole	16	1-0-2	PSK11	✓	
PSA020MS134S	1 Faz / 1 Pole	20	1-0-2	PSK11	✓	
PSA025MS134S	1 Faz / 1 Pole	25	1-0-2	PSK11	✓	
PSA032MS134S	1 Faz / 1 Pole	32	1-0-2	PSK21		
PSA040MS134S	1 Faz / 1 Pole	40	1-0-2	PSK21		
PSA050MS134S	1 Faz / 1 Pole	50	-	-		
PSA063MS134S	1 Faz / 1 Pole	63	-	-		
PSA080MS134S	1 Faz / 1 Pole	80	-	-		
PSA115MS134S	1 Faz / 1 Pole	115	-	-		

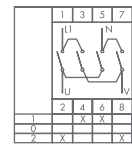

#### 3 Faz Aç- Kapa Şalterler 'I-0' / 3 Poles On-Off Cam Switches 'I-0'

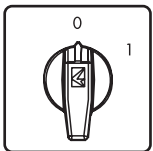

PSA020MS331S

Ürün Kodu Code	Faz Sayısı Poles	Anma Termik Akımı (A) Rated Thermal Current (A)	Kademe Steps	Uygun Kutu Kodu Enclosure	Anahtarlı Kafa Uyarlanabilir Key Operated	Kontakt Şeması Schema
PSA010MS331S	3 Faz / 3 Poles	10	0-1	PSK11	✓	
PSA016MS331S	3 Faz / 3 Poles	16	0-1	PSK11	✓	
PSA020MS331S	3 Faz / 3 Poles	20	0-1	PSK11	✓	
PSA025MS331S	3 Faz / 3 Poles	25	0-1	PSK11	✓	
PSA032MS331S	3 Faz / 3 Poles	32	0-1	PSK21		
PSA040MS331S	3 Faz / 3 Poles	40	0-1	PSK21		
PSA050MS331S	3 Faz / 3 Poles	50	-	-		
PSA063MS331S	3 Faz / 3 Poles	63	-	-		
PSA080MS331S	3 Faz / 3 Poles	80	-	-		
PSA115MS331S	3 Faz / 3 Poles	115	-	-		

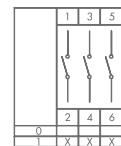

# Pako Şalterler ve Pako Kutuları

## Cam Switches and Enclosures

### 3 Faz Enversör Şalterler ' I - 0 - II '

#### 3 Poles Inversor Cam Switches ' I-0-II '

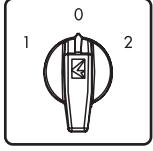

PSA020MS334S

Ürün Kodu Code	Faz Sayısı Poles	Anma Termik Akımı (A) Rated Thermal Current (A)	Kademe Steps	Uygun Kutu Kodu Enclosure	Anahtarlı Kafa Uyarlanabilir Key Operated	Kontakt Şeması Schema
PSA010MS334S	3 Faz / 3 Poles	10	1-0-2	PSK12	✓	
PSA016MS334S	3 Faz / 3 Poles	16	1-0-2	PSK12	✓	
PSA020MS334S	3 Faz / 3 Poles	20	1-0-2	PSK12	✓	
PSA025MS334S	3 Faz / 3 Poles	25	1-0-2	PSK12	✓	
PSA032MS334S	3 Faz / 3 Poles	32	1-0-2	PSK22		
PSA040MS334S	3 Faz / 3 Poles	40	1-0-2	PSK22		
PSA050MS334S	3 Faz / 3 Poles	50	1-0-2	-		
PSA063MS334S	3 Faz / 3 Poles	63	1-0-2	-		
PSA080MS334S	3 Faz / 3 Poles	80	1-0-2	-		
PSA115MS334S	3 Faz / 3 Poles	115	1-0-2	-		

### 3 Faz Çift Devir Şalterler ( 0-1-2 )

#### 3 Phase Double Cycle Motor Control Cam Switches (0-1-2)

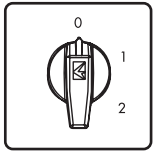

PSA016CD332S

Ürün Kodu Code	Faz Sayısı Poles	Anma Termik Akımı (A) Rated Thermal Current (A)	Uygun Kutu Kodu Enclosure	Anahtarlı Kafa Uyarlanabilir Key Operated	Kontakt Şeması Schema
PSA010CD332S	3 Faz / 3 Poles	10 A	PSK12	✓	
PSA016CD332S	3 Faz / 3 Poles	16 A	PSK12	✓	
PSA020CD332S	3 Faz / 3 Poles	20 A	PSK12	✓	
PSA025CD332S	3 Faz / 3 Poles	25 A	PSK12	✓	
PSA032CD332S	3 Faz / 3 Poles	32 A	PSK22		
PSA040CD332S	3 Faz / 3 Poles	40 A	PSK22		
PSA050CD332S	3 Faz / 3 Poles	50 A	-		
PSA063CD332S	3 Faz / 3 Poles	63 A	-		
PSA080CD332S	3 Faz / 3 Poles	80 A	-		
PSA115CD332S	3 Faz / 3 Poles	115 A	-		

### 3 Faz Çift Devir Şalterler ( 1-0-2 )

#### 3 Phase Double Cycle Motor Control Cam Switches (1-0-2)

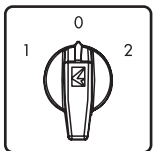

PSA016CD334S

Ürün Kodu Code	Faz Sayısı Poles	Anma Termik Akımı (A) Rated Thermal Current (A)	Uygun Kutu Kodu Enclosure	Anahtarlı Kafa Uyarlanabilir Key Operated	Kontakt Şeması Schema
PSA010CD334S	3 Faz / 3 Poles	10 A	PSK12	✓	
PSA016CD334S	3 Faz / 3 Poles	16 A	PSK12	✓	
PSA020CD334S	3 Faz / 3 Poles	20 A	PSK12	✓	
PSA025CD334S	3 Faz / 3 Poles	25 A	PSK12	✓	
PSA032CD334S	3 Faz / 3 Poles	32 A	PSK22		
PSA040CD334S	3 Faz / 3 Poles	40 A	PSK22		
PSA050CD334S	3 Faz / 3 Poles	50 A	-		
PSA063CD334S	3 Faz / 3 Poles	63 A	-		
PSA080CD334S	3 Faz / 3 Poles	80 A	-		
PSA115CD334S	3 Faz / 3 Poles	115 A	-		

- İstendiği takdirde, 10-25A bir büyük boy çerçeve ile montaj yapılabilir (64x64), bu durumda sondaki "S" yerine "B" konması gerekmektedir.
- Anahtarlı sütunda işaretli olan modeller çabuk montajlı Anahtarlı Kafa için uygundur.

\* 10-25A Cam switches could be supplied with big frame (64x64) with extra charge. In this case please replace the "S" at the end with "B".

\* Products are in the Key Operated columns are available for fast mounting Key Head with extra charge. In this case, replace S letter at the end of the code with AQ

## Ölçü Komütatörler - 45° / Measuring Cam Switches - 45°

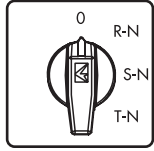

PSA0200K421S

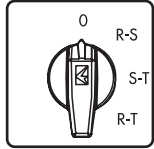

PSA0200K422S

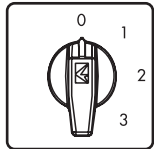

PSA0200K426S

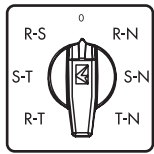

PSA0200K723S

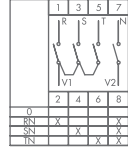
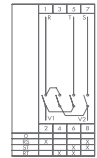
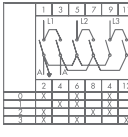
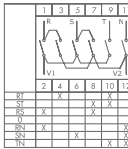
Ürün Kodu Code	Tip Type	Anma Termik Akımı (A) Rated Thermal Current (A)	Pozisyon Position	Uygun Kutu Kodu Enclosure	Anahtarlı Kafa Uyarlanabilir Key Operated	Kontakt Şeması Schema
PSA0100K421S	4	10	Voltmetre Voltmeter	PSK11		
PSA0160K421S	4	16	Voltmetre Voltmeter	PSK11		
PSA0200K421S	4	20	Voltmetre Voltmeter	PSK11		
PSA0100K422S	4	10	Faz-Faz Voltmetre Phase-Phase Voltmeter	PSK11		
PSA0160K422S	4	16	Faz-Faz Voltmetre Phase-Phase Voltmeter	PSK11		
PSA0200K422S	4	20	Faz-Faz Voltmetre Phase-Phase Voltmeter	PSK11		
PSA0100K426S	4	10	Ampermetre Ammeter	PSK12		
PSA0160K426S	4	16	Ampermetre Ammeter	PSK12		
PSA0200K426S	4	20	Ampermetre Ammeter	PSK12		
PSA0200K723S	7	20	Voltmetre Voltmeter	PSK12		



PSR1

## Aksesuarlar / Accessories

Ürün Kodu Code	Tip Type	Özellik Features	Malzeme Material
PSR1	Raya Montaj Aparatı Rail Mounting Interface	10 - 40 A arası Between 10-40	Plastik Plastic

## PAKO Kutuları / Cam Switch Boxes



PSK11

PSK12



PSK21

PSK22

Ürün Kodu Code	Malzeme Material	Özellik Features
PSK11	Plastik / Plastic	IP54
PSK12	Plastik / Plastic	IP54
PSK21	Plastik / Plastic	IP54
PSK22	Plastik / Plastic	IP54
PSK11E	Plastik / Plastic	IP65
PSK12E	Plastik / Plastic	IP65
PSK21E	Plastik / Plastic	IP65
PSK22E	Plastik / Plastic	IP65



# Pako Şalterler ve Pako Kutuları

## Cam Switches and Enclosures

### Anahtarlı Pako

Cam Switches With Key

#### BOYUTLAR (mm) / DIMENSIONS (mm)

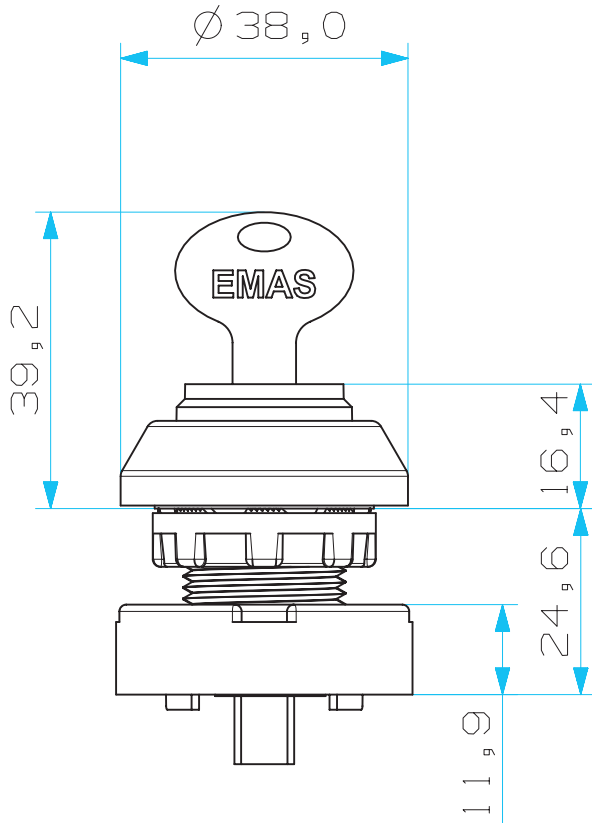

**Montaj Delik Ölçüsü  $\varnothing 22$  mm**  
Mounting Hole Diameter  $\varnothing 22$ mm

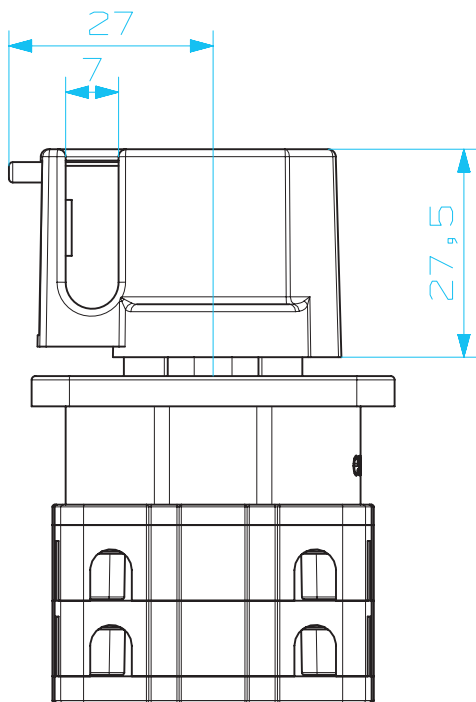
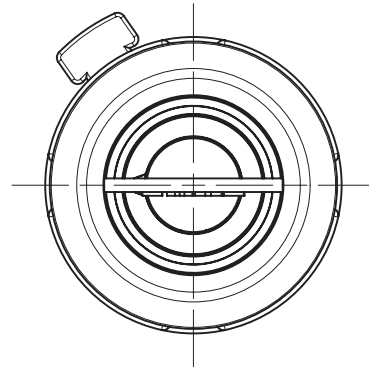

## Pako Kutular

Cam Switches Boxes

### MONTAJ ÖLÇÜLERİ (mm) MOUNTING DIMENSIONS (mm)

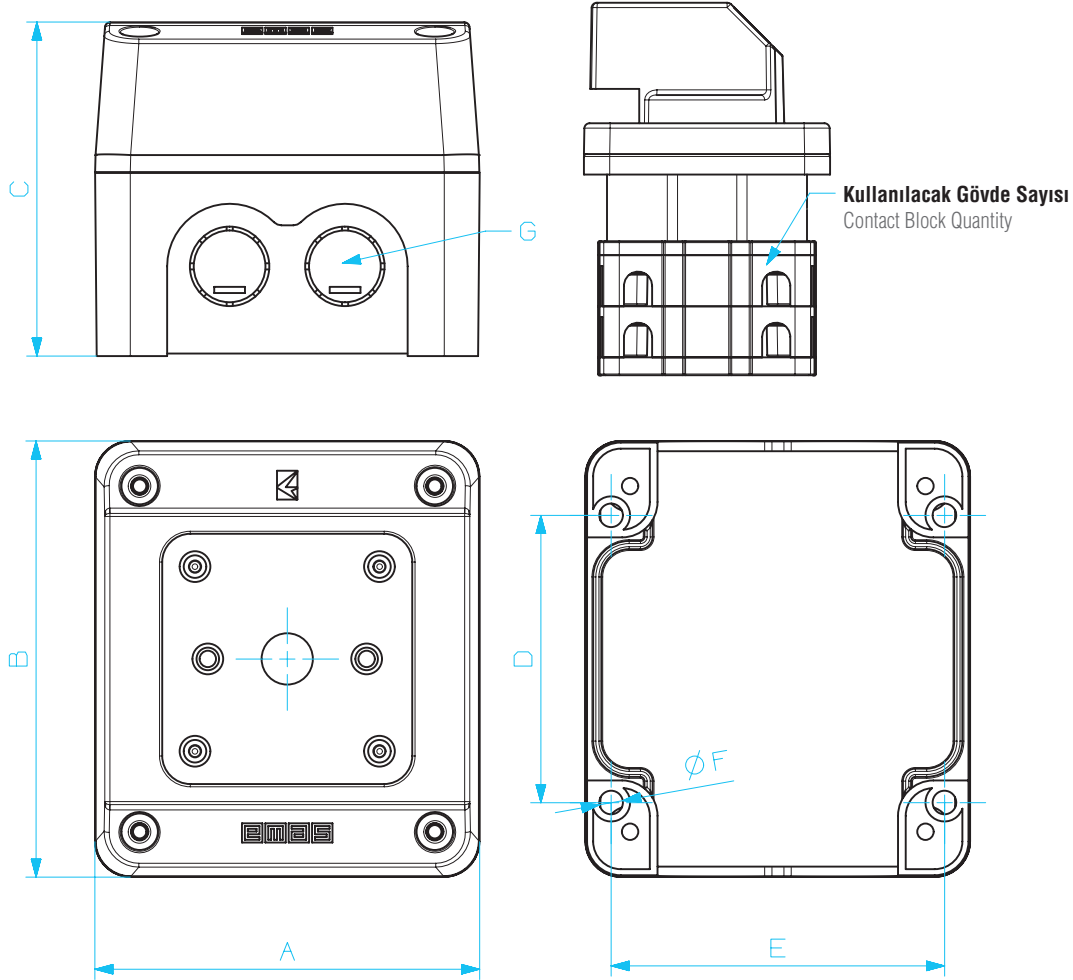

Ürün Kodu / Code	Montaj Ölçüleri / Mounting Dimensions						Rakor Cable Gland
	A	B	C	D	E	F	G
PSK11	75	85	65	56	65	4,6	PG9
PSK12	75	85	89	56	65	4,6	PG9
PSK21	91	101	73,5	72	81	4,6	PG11
PSK22	91	101	103,5	72	82	4,6	PG11

Ürün Kodu / Code	Kullanılan Pako Gövde Sayısı / Contact Block Quantity
PSK11	10A - 25A arası 1 ve 2 gövdeli Pako Şalterler
PSK12	10A - 25A arası 3 ve 4 gövdeli Pako Şalterler
PSK21	32A - 40A arası 1 ve 2 gövdeli Pako Şalterler
PSK22	32A - 40A arası 3 ve 4 gövdeli Pako Şalterler

# Pako Şalterler ve Pako Kutuları

## Cam Switches and Enclosures

### Teknik Özellikler / Technical Specifications

Siviç Tipi Switch Type			PSA010	PSA016	PSA020	PSA25	PSA32	PSA040	PSA050	PSA063	PSA080		
İzolasyon gerilimi	Rated Insulation Voltage $U_i$		400				690						
Darbe dayanım gerilimi	Rated impulse withstand Voltage $U_{imp}$		4				4						
Anlık termal akım	Rated thermal current $I_{th}$		16	20	25	32	40	50	50	70	80		
Ana Şalter İşletme geriliminin maksimum değeri	Main Switch Max. value of rated (1) operational voltage						480						
Darbe dayanım gerilimi	Rated impulse withstand voltage						4						
Kısa devre koruması için max. sigorta boyutu	Max. fuse size for short circuit protection $I_{sc}$ 10kA		16	20	25	32	40	50	50	70	80		
Kısa devre akımına dayanma süresi	1 sn. 3 sn. 10 sn. 30 sn. 60 sn.	Rated short-time withstand current $I_{cw}$	1 sec	A	150	180	200	400	600	800	800	800	1000
			3 sec	A	100	110	120	250	400	530	700	700	800
			10 sec	A	50	60	70	140	240	290	350	350	400
			30 sec	A	25	30	40	90	150	200	250	250	250
			60 sec	A	20	25	30	70	120	150	150	150	160
Anma işletme akımı	Rated operational current $I_e$ AC1 / AC21		A	10	16	20	25	32	40	50	63	70	
Anma işletme akımı	Rated operational current $I_e$ AC15		110 V	A	8	8	10	20	25	40	50	50	63
			220/230 V	A	8	8	8	20	25	40	50	50	63
			380/400 V	A	4	4	6	16	20	25	40	40	45
			660/690 V	A	4	4	6	8	8.5	8.5	10	10	10
Kullanma sınıfı AC3	Motor switch in utilization category AC3	3 faz	220/230 V	kW	1.5	3	3	5.5	7.5	9	11	11	12
			380/400 V	kW	1.6	5	5	7.5	11	15	18.5	18.5	22
			500/690 V	kW	4	6	8.5	11	15	19	22	22	28
		1 faz 2 kutup	110 V	kW	0.5	0.8	0.8	1.5	2.5	3	-	-	-
			220/230 V	kW	1.5	2.5	3	5.5	6.5	7.5	-	-	-
			380/400 V	kW	2	2.5	3	5.5	6.5	7.5	-	-	-
AC23	AC23	3 faz	220/230 V	kW	3	5	5	6.5	8	9	15	15	18.5
			380/400 V	kW	5	7	7.5	11	15	18.5	22	22	32
			500/690 V	kW	-	-	-	11	18.5	22	30	30	45
		1 faz 2 kutup	110 V	kW	0.8	0.8	0.8	1.5	2.5	3	3.5	3.5	-
			220/230 V	kW	1.7	2.5	2.5	3.7	5	6	9	9	-
			380/400 V	kW	2.8	3.7	3.7	5.5	7.5	9	15	15	-
AC4	AC4	3 faz	220/230 V	kW	0.75	1	1.5	2.5	3	5	6	6	7
			380/400 V	kW	1	1.5	2	4	5.5	8	11	11	12
			500/690 V	kW	-	-	-	4	7.5	8	11	11	12
Mekanik dayanım şalterleme devri	Mechanical Endurance switching cycles		10 <sup>5</sup>	1	1	1	1	1	1	1	1		
Vida bağlantıları	Terminal Screw		M3.5	M3.5	M3.5	M3.5	M4	M4	M5	M5	2XM5		
Bağlantı kablosu kesiti	rijit fleksibil	Cable cross section	rigid flexible	mm <sup>2</sup>	2X(1-2.5) 2-4*	2X(1-2.5) 2-4*	2X(1-2.5) 2-4*	2X(1-4) 1-6*	2X(2.5-6) 1-10*	2X (2.5-10)	2X(4-16)	2X(4-16)	10-25
					2X(1-2.5) 2-4*	2X(1-2.5) 2-4*	2X(1-2.5) 2-4*	2X(1-4)	2X(2.5-6) 1-10*	2X (2.5-10)	2X(4-16)	2X(4-16)	6-16 2X(6-10)

(1) Aşırı gerilim kategorisi III, kirlenme derecesi 3, nötr topraklı sistemler için geçerli.

(\*) Dahili bağlantısı olmayan diagramlar için geçerlidir.

(1) Valid for neutral earthed systems, overvoltage category III, pollution degree 3

(\*) Only for diagrams without inside links.

## MONTAJ ŞEKİLLERİ VE BOYUTLAR (mm) / ASSEMBLY TYPE AND DIMENSIONS (mm)

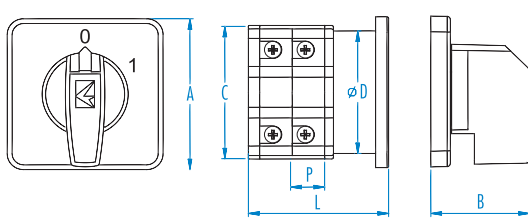



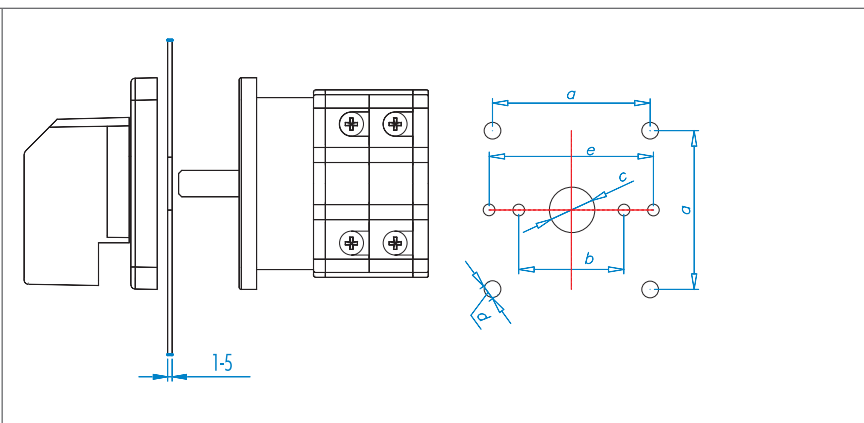
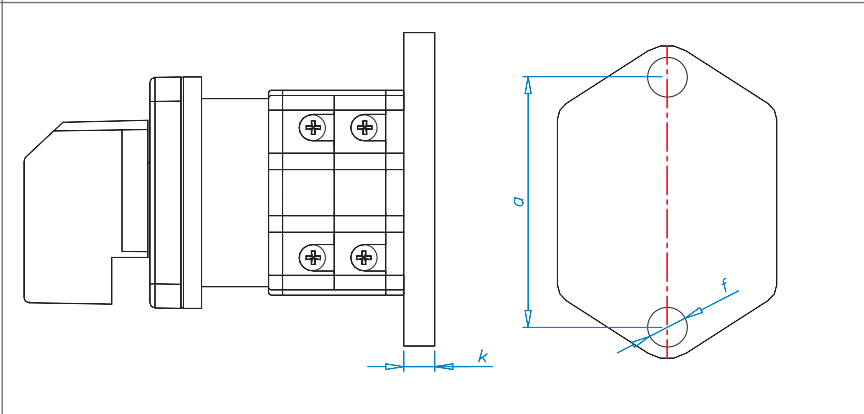





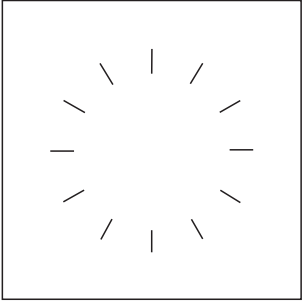
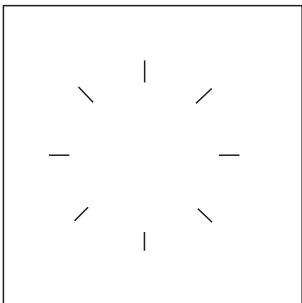













	L												
	A	B	C	D	P	1	2	3	4	5	6	7	8
PSA10	48	30,5	42,5	27	10	33,2	43,2	53,2	63,2	73,2	83,2	93,2	103,2
PSA16	48	30,5	42,5	27	10	33,2	43,2	53,2	63,2	73,2	83,2	93,2	103,2
PSA20	48	30,5	42,5	27	10	33,2	43,2	53,2	63,2	73,2	83,2	93,2	103,2
PSA25	48	30,5	42,5	27	12	35,2	47,2	59,2	71,2	83,2	95,2	107,2	119,2
PSA32	64	38	55	55	13	39,2	52,2	65,2	78,2	91,2	104,2	111,2	130,2
PSA40	64	38	55	55	15	41,2	56,2	71,2	86,2	101,2	116,2	131,2	146,2

<p><b>PANO KAPAGINA MONTAJ</b> MOUNTING TO PANEL COVER</p>		<table border="1"> <thead> <tr> <th></th> <th>a</th> <th>b</th> <th>c</th> <th>d</th> </tr> </thead> <tbody> <tr> <td>PSA10</td> <td>36</td> <td>30</td> <td>9,5</td> <td>4,3</td> </tr> <tr> <td>PSA16</td> <td>36</td> <td>30</td> <td>9,5</td> <td>4,3</td> </tr> <tr> <td>PSA20</td> <td>36</td> <td>30</td> <td>9,5</td> <td>4,3</td> </tr> <tr> <td>PSA25</td> <td>36</td> <td>30</td> <td>9,5</td> <td>4,3</td> </tr> <tr> <td>PSA32</td> <td>48</td> <td>30</td> <td>50</td> <td>10</td> </tr> <tr> <td>PSA40</td> <td>48</td> <td>30</td> <td>50</td> <td>10</td> </tr> </tbody> </table>		a	b	c	d	PSA10	36	30	9,5	4,3	PSA16	36	30	9,5	4,3	PSA20	36	30	9,5	4,3	PSA25	36	30	9,5	4,3	PSA32	48	30	50	10	PSA40	48	30	50	10
	a	b	c	d																																	
PSA10	36	30	9,5	4,3																																	
PSA16	36	30	9,5	4,3																																	
PSA20	36	30	9,5	4,3																																	
PSA25	36	30	9,5	4,3																																	
PSA32	48	30	50	10																																	
PSA40	48	30	50	10																																	
<p><b>PANO TABANINA MONTAJ</b> MOUNTING TO PANEL BASE</p>		<table border="1"> <thead> <tr> <th></th> <th>a</th> <th>f</th> <th>k</th> </tr> </thead> <tbody> <tr> <td>PSA10</td> <td>52</td> <td>4,3</td> <td>6</td> </tr> <tr> <td>PSA16</td> <td>52</td> <td>4,3</td> <td>6</td> </tr> <tr> <td>PSA20</td> <td>52</td> <td>4,3</td> <td>6</td> </tr> <tr> <td>PSA25</td> <td>52</td> <td>4,3</td> <td>6</td> </tr> <tr> <td>PSA32</td> <td>65</td> <td>5,5</td> <td>7</td> </tr> <tr> <td>PSA40</td> <td>65</td> <td>5,5</td> <td>7</td> </tr> </tbody> </table>		a	f	k	PSA10	52	4,3	6	PSA16	52	4,3	6	PSA20	52	4,3	6	PSA25	52	4,3	6	PSA32	65	5,5	7	PSA40	65	5,5	7							
	a	f	k																																		
PSA10	52	4,3	6																																		
PSA16	52	4,3	6																																		
PSA20	52	4,3	6																																		
PSA25	52	4,3	6																																		
PSA32	65	5,5	7																																		
PSA40	65	5,5	7																																		

# Pako Şalterler ve Pako Kutuları

## Cam Switches and Enclosures

		ÖZEL SİPARİŞ FORMU																									
		SPECIAL ORDER FORM																									
İşletme Gerilimi Rated Voltage	V	Şalter Tipi Type of Switch	PS	Montaj Formu Mounting Form		Diyagram No. Diagram No.																					
İşletme Akımı Rated Current	A	Kullanma Kategorisi Utilization Category				Özel Versiyon Special Version																					
Bağlantı Diyagramı Connection Diagram		Bağlantı Diyagramı Connection Diagram																									
																											
	<input type="checkbox"/> 30° <input type="checkbox"/> 60°																										
	<input type="checkbox"/> 45° <input type="checkbox"/> 90°																										
		1	4	5	8	9	12	13	16	17	20	21	24	25	28	29	32	33	36	37	40	41	44	45	48		
																											
		2	3	6	7	10	11	14	15	18	19	22	23	26	27	30	31	34	35	38	39	42	43	46	47		
Devre Pozisyonu Düzenleme Tablosu Arrangement Of Position Marks On Front Plate																											
Not: Note:																											
		Firma Adı/Company Name _____																									
		Adres/Address _____																									
		_____																									
		Tel./Telephone _____ Faks/Fax _____ Bilgi/Data _____																									