



MN Serisi Mini Siviçler

- Geniş uygulama alanları için ürün çeşitliliği
- Uzun ömür
- Yüksek kontak güvenilirliği
- Standart montaj delikleri

Teknik Bilgiler

Mekanik Ömür	: 500.000 açma-kapama min. (60 dev/dk)
Elektriksel Ömür	: 100.000 açma-kapama min. (30dev/dk)
Çalışma Sıcaklığı	-15/+125 °C

Koruma Sınıfı

MN Serisi Tip 1 Mini Siviçler	: IP20 - IP40 (Koruma Çerçevesi)
MN Serisi Tip 2 Mini Siviçler	: IP20 - IP40 (Koruma Çerçevesi)
MN Serisi Tip 3 Metal Mini Siviçler	: IP65
MN Serisi Tip 4 Mini Siviçler	: IP20 - IP40 (Koruma Çerçevesi)

Çalışma Gerilimi (Ue)	: 440V AC
Çalışma Akımı (Ie)	: 10A
Yalıtım Gerilimi (Ui)	: 660V
Darbe Dayanım Gerilimi (Uimp)	: 2,5 kV
Kısa Devre Kesme Kap. (Icn)	: 1 kA
Çalışma Frekansı(f)	: 50 Hz.
İzolasyon Direnci	: 10 MΩ min. (500V DC)
Kullanım Sınıfı	: AC15
Dielektrik Mukavemeti	: 1.500V AC (1 dakika için)
Kirlenme Derecesi	: 3
Bağlantı Kablo Kesiti	: 1,5-2,5 mm ²
Standart	: TS EN 60947-5-1



MN Series Mini Switches

- Variety of products for wide applications
- Long life time
- High contact reliability
- Standard mounting holes

Technical Information

Mechanical Life	: 500.000 operations min. (60 cyc/min)
Electrical Life	: 100.000 operations min. (30 cyc/min)
Operating Temperature	: -15/+125 °C

Protection Degree

MN Series Type 1 Mini Switches	: IP20 - IP40 (with Protection Housing)
MN Series Type 2 Mini Switches	: IP20 - IP40 (with Protection Housing)
MN Series Type 3 Metal Mini Switches	: IP65
MN Series Type 4 Mini Switches	: IP20 - IP40 (with Protection Housing)

Operating Voltage (Ue)	: 440V AC
Operating Current (Ie)	: 10A
Insulation Voltage (Ui)	: 660V
Impact Resistance (Uimp)	: 2,5 kV
Short Circuit Breaking Capacity (Icn)	: 1 kA
Operating Frequency (f)	: 50 Hz.
Insulation Resistance	: 10 MΩ min. (500V DC)
Utilization Category	: AC15
Dielectric Strength	: 1.500V AC (for 1 minute)
Pollution Degree	: 3
Cable Section	: 1,5-2,5 mm ²
Standard	: TS EN 60947-5-1



MN Serisi Tip 2 Mini Siviçler / MN Series Type 2 Mini Switches



Kısa Kollu
Short Hinge Lever

Ürün Kodu	Kontakt Yapısı	Kontakt Şeması	Duyar Blok Tipi	Duyar Blok Malzemesi
Code	Contact Type	Contact Scheme	End Unit Type	End Unit Material

MN2KIM1	1 Değişebilen Kontakt 1 Changeover Contact		Kol Hinge Lever	Metal Metal
---------	---	--	--------------------	----------------



Orta Kollu
Medium Hinge Lever

Ürün Kodu	Kontakt Yapısı	Kontakt Şeması	Duyar Blok Tipi	Duyar Blok Malzemesi
Code	Contact Type	Contact Scheme	End Unit Type	End Unit Material

MN2KIM2	1 Değişebilen Kontakt 1 Changeover Contact		Kol Hinge Lever	Metal Metal
---------	---	--	--------------------	----------------



Uzun Kollu
Long Hinge Lever

Ürün Kodu	Kontakt Yapısı	Kontakt Şeması	Duyar Blok Tipi	Duyar Blok Malzemesi
Code	Contact Type	Contact Scheme	End Unit Type	End Unit Material

MN2KIM3	1 Değişebilen Kontakt 1 Changeover Contact		Kol Hinge Lever	Metal Metal
---------	---	--	--------------------	----------------



Kısa Kollu Makaralı
Short Hinge Roller Lever

Ürün Kodu	Kontakt Yapısı	Kontakt Şeması	Duyar Blok Tipi	Duyar Blok Malzemesi
Code	Contact Type	Contact Scheme	End Unit Type	End Unit Material

MN2MIM1	1 Değişebilen Kontakt 1 Changeover Contact		Kollu Makara Hinge Lever	Metal Metal
---------	---	--	-----------------------------	----------------



Kısa Kollu Yaylı Makaralı
Short Hinge Roller Lever With Springs

Ürün Kodu	Kontakt Yapısı	Kontakt Şeması	Duyar Blok Tipi	Duyar Blok Malzemesi
Code	Contact Type	Contact Scheme	End Unit Type	End Unit Material

MN2MIM1Y	1 Değişebilen Kontakt 1 Changeover Contact		Kollu Makara Hinge Lever	Metal Metal
----------	---	--	-----------------------------	----------------



Uzun Kollu Makaralı
Long Hinge Roller Lever

MN Serisi Tip 2 Mini Siviçler / MN Series Type 2 Mini Switches

Ürün Kodu	Kontakt Yapısı	Kontakt Şeması	Duyar Blok Tipi	Duyar Blok Malzemesi
Code	Contact Type	Contact Scheme	End Unit Type	End Unit Material
MN2MIM2	1 Değişebilen Kontakt 1 Changeover Contact		Kollu Makara Hinge Lever	Metal Metal



Pimli Eksene Paralel Makaralı
Panel Mount Roller Plunger

Ürün Kodu	Kontakt Yapısı	Kontakt Şeması	Duyar Blok Tipi	Duyar Blok Malzemesi
Code	Contact Type	Contact Scheme	End Unit Type	End Unit Material
MN2MUM3	1 Değişebilen Kontakt 1 Changeover Contact		Pimli Makara Plunger	Metal Metal



Pimli Eksene Dik Makaralı
Panel Mount Cross Roller Plunger

Ürün Kodu	Kontakt Yapısı	Kontakt Şeması	Duyar Blok Tipi	Duyar Blok Malzemesi
Code	Contact Type	Contact Scheme	End Unit Type	End Unit Material
MN2MUM8	1 Değişebilen Kontakt 1 Changeover Contact		Pimli Makara Plunger	Metal Metal



İnce Kısa Pimli
Pin Plunger

Ürün Kodu	Kontakt Yapısı	Kontakt Şeması	Duyar Blok Tipi	Duyar Blok Malzemesi
Code	Contact Type	Contact Scheme	End Unit Type	End Unit Material
MN2PUM1	1 Değişebilen Kontakt 1 Changeover Contact		Pim Plunger	Metal Metal



İnce Uzun Pimli
Tall Pin Plunger

Ürün Kodu	Kontakt Yapısı	Kontakt Şeması	Duyar Blok Tipi	Duyar Blok Malzemesi
Code	Contact Type	Contact Scheme	End Unit Type	End Unit Material
MN2PUM3	1 Değişebilen Kontakt 1 Changeover Contact		Pim Plunger	Metal Metal

MN Serisi Tip 2 Mini Siviçler / MN Series Type 2 Mini Switches



Kalın Kısa Pimli
Short Spring Plunger

Ürün Kodu	Kontakt Yapısı	Kontakt Şeması	Duyar Blok Tipi	Duyar Blok Malzemesi
Code	Contact Type	Contact Scheme	End Unit Type	End Unit Material
MN2PUM7	1 Değişebilen Kontakt 1 Changeover Contact		Pim Plunger	Metal Metal



Kalın Uzun Pimli
Panel Mount Plunger

Ürün Kodu	Kontakt Yapısı	Kontakt Şeması	Duyar Blok Tipi	Duyar Blok Malzemesi
Code	Contact Type	Contact Scheme	End Unit Type	End Unit Material
MN2PUM9	1 Değişebilen Kontakt 1 Changeover Contact		Pim Plunger	Metal Metal



Plastik Tutamaklı
Plastic Handle

Ürün Kodu	Kontakt Yapısı	Kontakt Şeması	Duyar Blok Tipi	Duyar Blok Malzemesi
Code	Contact Type	Contact Scheme	End Unit Type	End Unit Material
MN2TIP11	1 Değişebilen Kontakt 1 Changeover Contact		Tutamak Handle	Plastik Plastic
MN2TIP12	1 Değişebilen Kontakt 1 Changeover Contact		Tutamak Handle	Plastik Plastic

BOYUTLAR (mm) / DIMENSIONS (mm)

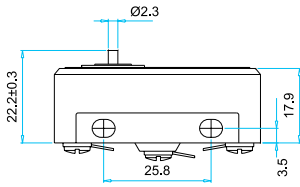

MN2PUM1

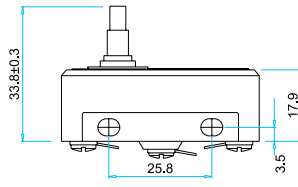

MN2PUM3

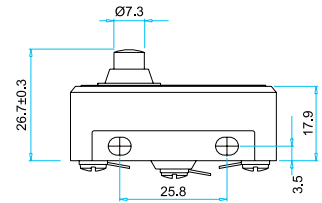

MN2PUM7

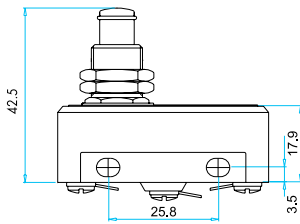

MN2PUM9

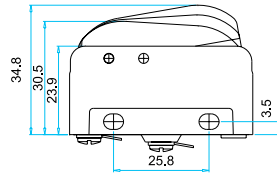

MN2TIP11/MN2TIP12

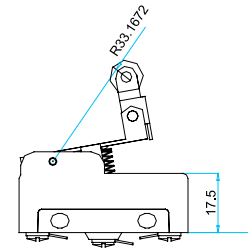

MN2MIM1Y

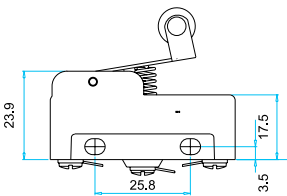

MN2MIM1

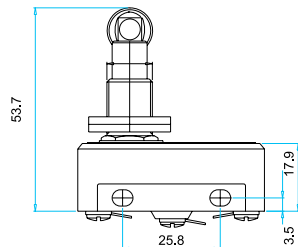

MN2MUM3

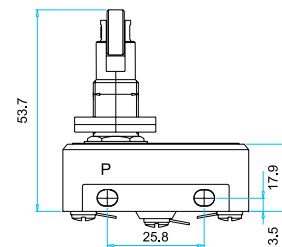

MN2MUM8

BOYUTLAR (mm) / DIMENSIONS (mm)

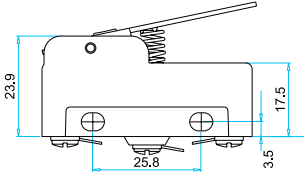

MN2KIM1

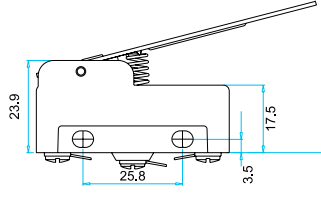

MN2KIM2

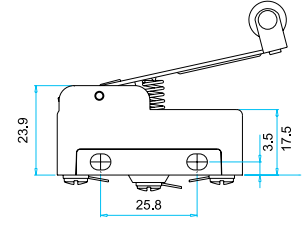

MN2MIM2

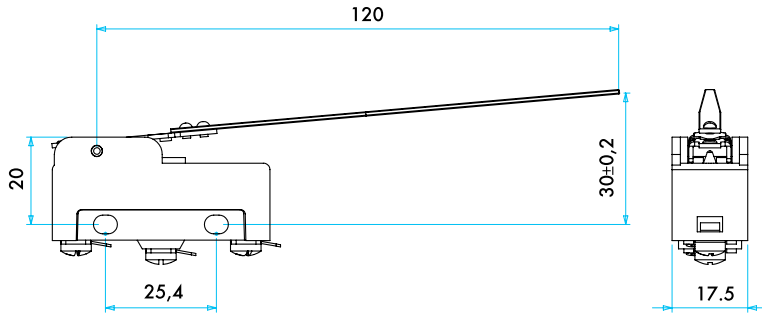

MN2KIM3